

Technical data sheet

Product features



Display unit heated, suchá GN 4-1/1 drop-in

Model	SAP Code	00012090
--------------	-----------------	----------



- Buffet type: ORANGE - heated, dry
- Device properties: Warmed
- Number of GN / EN: 4
- GN / EN size in device: GN 1/1
- GN device depth: 200
- Minimum device temperature [°C]: 60
- Maximum device temperature [°C]: 100

SAP Code	00012090	Loading	230 V / 1N - 50 Hz
Net Width [mm]	650	Number of GN / EN	4
Net Depth [mm]	1494	GN / EN size in device	GN 1/1
Net Height [mm]	290	GN device depth	200
Net Weight [kg]	31.00	Minimum device temperature [°C]	60
Power electric [kW]	2.000	Maximum device temperature [°C]	100

Technical data sheet

Technical drawing



Display unit heated, suchá GN 4-1/1 drop-in

Model

SAP Code

00012090

A= ELECTRICAL CONNECTION
 D= WATER DISCHARGE G1/2" (M) ONLY BM
 E= WATER INLET G3/4" (M) ONLY BM

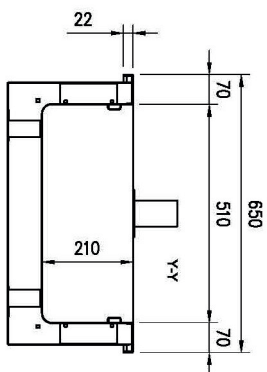
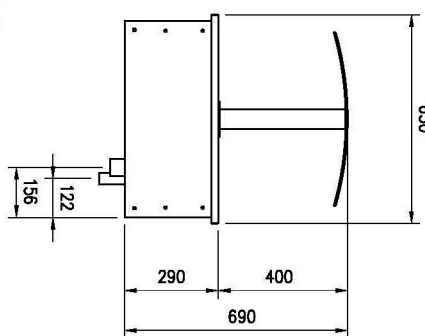
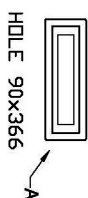
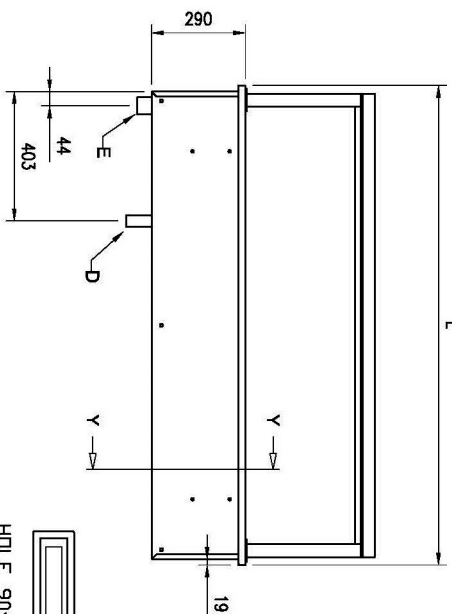
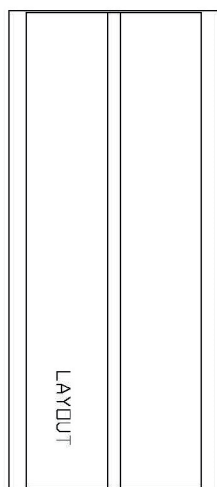

GN	L	HOLE
2/1	844	814x620
3/1	1169	1139x620
4/1	1494	1464x620
5/1	1819	1789x620
6/1	2144	2114x620

FLAT

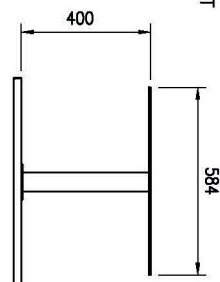

SERVICE

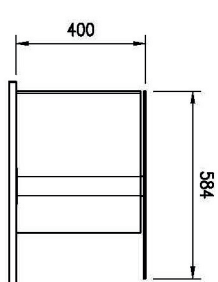

TRADITION

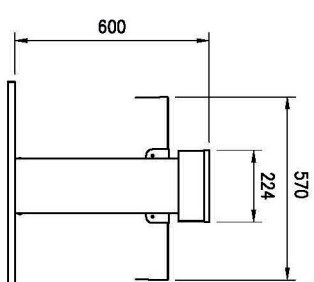

Technical data sheet

Product benefits



Display unit heated, suchá GN 4-1/1 drop-in

Model	SAP Code	00012090
-------	----------	----------

1

Built-in

the possibility to plant in a dispensing block design

- unified design of the dispensing line
- a luxurious look that customers appreciate

2

One large bathtub

one controller for the whole tub

- very easy to use
- easy maintenance

3

GN insertion up to 200mm

variability of use

- possibility of heating different types of food and larger volumes
- saving time, space, costs

4

Rounded corners

basins without sharp edges and corners

- higher hygienic safety
- time saving due to easy cleaning

5

All-stainless steel construction

basins without sharp edges and corners

- long service life
- very easy to clean

Technical data sheet

Technical parameters



Display unit heated, suchá GN 4-1/1 drop-in

Model

SAP Code

00012090

1. SAP Code:

00012090

2. Net Width [mm]:

650

3. Net Depth [mm]:

1494

4. Net Height [mm]:

290

5. Net Weight [kg]:

31.00

6. Gross Width [mm]:

730

7. Gross depth [mm]:

1530

8. Gross Height [mm]:

700

9. Gross Weight [kg]:

37.00

10. Device type:

Electric unit

11. Material:

AISI 304

12. Buffet type:

ORANGE - heated, dry

13. Device properties:

Warmed

14. Exterior color of the device:

Stainless steel

15. Power electric [kW]:

2.000

16. Loading:

230 V / 1N - 50 Hz

17. Number of GN / EN:

4

18. GN / EN size in device:

GN 1/1

19. GN device depth:

200

20. Minimum device temperature [°C]:

60

21. Maximum device temperature [°C]:

100

22. Cross-section of conductors CU [mm²]:

0,5

- Výkon (kW): 2,4-3,3 (230 V)